

SIS SYSTEM  
SAFETY RELAY

安全继电器

适配各类SIS控制器



SIL3

功能安全认证  
Functional safety certification

G3防腐  
G3 anticorrosion

6年质保  
Six-year warranty



# 公司简介

COMPANY PROFILE



北京平和始创于2004年1月，座落于北京市中关村科技园，总注册资本8000万元，是一家致力于工业信号类接口模块仪表的国家级高新技术企业。作为行业公认的一线品牌，北京平和一直专注于工控产品的研发、生产和营销，拥有两大智能制造基地。产品广泛应用于军工核电、航天航空、石油化工、冶金电力、能源环保、船舶制造和生物医药等行业。至今国内外市场稳定运行500余万只，卓越的品质和优质的服务获得了广大合作伙伴的高度信赖和认可。

Beijing Pinghe was founded in January 2004 and is located in Beijing Zhongguancun Science and Technology Park with registered capital 80 million CNY. We are a national high-tech enterprise dedicated to industrial signal interface modules. As a top brand recognized by the industry, Beijing Pinghe has main focused on R&D, production and sales in the industrial control area, possesses two big intelligent production bases. The products are broad-range used in the military nuclear power, aerospace, petrochemical, metallurgical power, energy and environmental protection, shipbuilding and biomedicine industries. So far, more than 5 million pieces run stable in domestic and foreign markets, our excellent quality and outstanding service have been highly recognized and praised by a vast number of partners.

## 企业荣誉 ENTERPRISE HONORS

国家级高新技术企业  
National high-tech enterprise

北京市“专精特新”中小企业  
Specialization, refinement, differentiation, innovation of  
small and medium-sized enterprise Beijing

北京市“专精特新”小巨人  
Specialization, refinement, differentiation, innovation  
of Little Giant enterprise Beijing

全国监督检查产品质量稳定合格企业  
National supervision and inspection product  
qualified enterprise of stable quality

北京市两化融合试点企业  
Pilot Enterprise Beijing of Integration of  
Informatization and Industrialization

中国制药装备行业协会会员单位  
Member of China Association For  
Pharmaceutical Equipment

中国仪器仪表学会会员单位  
Member of China Instrument and Control Society

中国计量协会会员单位  
Member of China Metrology Association

## 产品认证及殊荣 PRODUCT CERTIFICATION AND HONORS

TÜV 功能安全认证  
TÜV Functional safety certification

ATEX 防爆认证  
Quality assurance certified according to  
ATEX Approval

IECEX 防爆质量管理体系认证  
Quality assurance certified according to  
IECEX Approval

ISO 9001、ISO 14001、ISO 45001 管理体系认证  
Quality assurance certified according to  
ISO 9001, ISO 14001, ISO 45001

防爆产品 CCC 强制性认证  
China Compulsory Certification for  
explosion-proof products

北京市新技术新产品（服务）证书  
Beijing New Technology and New Product (Service)  
Certificate

2020 年度仪表自动化创新产品（技术）奖  
2020 Instrument Automation Innovation  
Product (Technology) Award

## 优秀的研发团队

EXCELLENT R&D TEAM

北京平和得益于首都北京人才与技术优势，高级工程师占研发团队的60%，研发人员占员工总数的30%以上。经过近20年积累，拥有多项专利和自主知识产权，掌握产品核心技术，充分满足了流程工业和过程工业等领域的需求。

我们制定积极的创新战略，关注国际最前端技术和方向，致力于研发符合更高安全要求的防雷、防爆解决方案，为客户创造更多附加值。

We benefit from talent and technical advantages of the capital Beijing, our senior engineers account for 60% of the R&D team, and R&D personnel more than 30% of the total number of employees. In these nearly 20 years, we have obtained a number of patents and independent intellectual property rights, and mastered the core technologies of the products, which fully meets the requirements of process industry.

We formulate an active innovation strategy, pay attention to the international most advanced technology and direction, and devote ourselves to research and develop lightning protection and explosion-proof solutions that meet higher safety requirements in order to create more added values for customers.







## 严谨的品质管控体系

STRICT QUALITY CONTROL SYSTEM



北京平和质量管控实施“全面质量管理”（Total Quality Management），在产品的设计、生产和服务的各个过程中实施严格的质量管控，为客户提供合格稳定的产品和及时优质的服务。北京平和始终以客户需求做为唯一服务标准，倾听客户声音，关注客户不断变化的需求，强化各个过程的质量管理，不断改进以提升客户满意度，矢志追求为客户提供高品质产品和全方位优质服务。

The quality control of Beijing Pinghe implements the "Total Quality Management" system standards, which carry out strict quality control in each process of product design, production and service, and provide customers with qualified and stable products as well as timely and high-quality services. Beijing Pinghe always takes the needs of customer as only service standard, listens to the opinion of customers, pays attention to the changing needs of customers, strengthens the quality management of each process, strives for providing customers with high-quality products and comprehensive services.

输入设备 Input Devices	型号 Model	电源 Power Supply	触点切换点容量 Utilisation category	继电器输出 Relay Output				页码 Page
				安全输出		辅助输出		
								
	PH6001-1A	24V DC	5A	1	-	-	-	5
	PH6002-2A	24V DC	5A	2	-	-	-	6
	PH6003-1A	24V DC	5A	1	-	-	-	7
	PH6003-1B	24V DC	5A	-	-	1	-	8
	PH6004-3A1B	24V DC/AC	5A	3	-	1	-	9
	PH6005-2A2B	24V DC/AC	5A	2	-	2	-	10

## 产品特点

The advantages

### SIS系统 安全继电器

- 冗余回路设计
- 继电器触点离线校验
- 失效安全技术
- 触点熔接保护

### SIS System Safety Relay

- Redundant circuit design
- Offline Proof Test of relay contacts
- Fail-safe technology
- Contact welding protection

### 机械系统 安全继电器

- 配置双通道安全条件，对双通道输入信号进行实时监控
- 特殊的逻辑结构设计，在单功能故障情况下，保障安全输出
- 安全输出进行反馈监控，功能异常消除，安全隐患不积累

### Mechanical System Safety Relay

- Configure dual-channel safety conditions to monitor dual-channel input signals in real-time
- Special logical structure design, guarantee safe output in case of single function failure
- Function integrity feedback-monitoring until the functional abnormality is eliminated, hidden danger will not be accumulated

# PH6001-1A

适用于SIS系统中DI/DO信号输入  
Applied in SIS controller DI/DO signals input



## 电源特性 Power data

供电电压 Supply voltage	17V~35V DC
电流损耗 Current consumption	≤60mA (24V DC)

## 输入特性 Input data

通道数 Number of channels	1
输入电流 Input current	≤60mA (24V DC)
导线电阻 Cable resistance	≤15Ω
输入设备 Input devices	SIS系统DI/DO信号配套 SIS controller DI/DO signals

## 输出特性 Output data

触点数量 Number of contacts	1NO
触点材料 Contact material	AgSnO <sub>2</sub>
触点熔丝保护 Excontact fuse protection	5A (Internal)
切换容量 Utilisation category	5A/230V AC; 5A/24V DC

## 时间特性 Time data

吸合缓冲时间 Switch-on delay	≤30ms
释放缓冲时间 Delay-on de-energisation	≤30ms
恢复时间 Recovery time	≤30ms
电源短时中断 Supply short interruption	20ms

## 环境特性 Environmental data

电磁兼容 EMC	EN60947, EN61000-6-2, EN61000-6-4
振动频率 Vibration frequency	10Hz~55Hz
振动幅度 Vibration amplitude	0.35mm
使用温度 Ambient temperature	-20℃~+60℃
储存温度 Storage temperature	-40℃~+80℃
相对湿度 Relative humidity	10%~90%

## 绝缘特性 Insulation data

过压等级 Overvoltage category	III
污染等级 Pollution degree	2
额定绝缘电压 Rated insulation voltage	250V AC
额定冲击电压 Rated impulse voltage	6000V (1.2/50us)
绝缘强度 Dielectric strength	1500V AC, 1min
电气间隙和爬电距离 Clearance and creepage distance	EN 60947-1

## 功能安全参数 Functional safety parameters

安全完整性等级 SIL	SIL3
硬件故障裕度 HFT	0
危险失效概率 PFH	< 1.00E <sup>-09</sup>
平均危险失效时间 MTTFD	-
安全失效分数 SFF	>99%

## 产品特征 Features

- 独立单通道 Separate one channels
- 三重冗余 Triple redundancy
- 内部触点熔丝保护 Internal Excontact fuse protection
- 带Proof Test测试端 With proof test terminal

## 功能框图 Block diagram

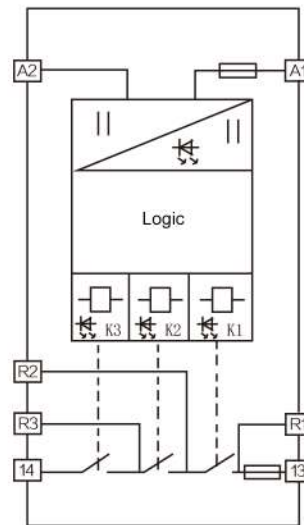

## 接线示意图 Wiring diagram

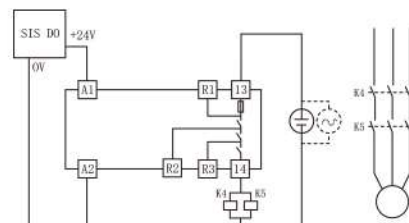

SIS系统DO信号配套 SIS controller DO signals

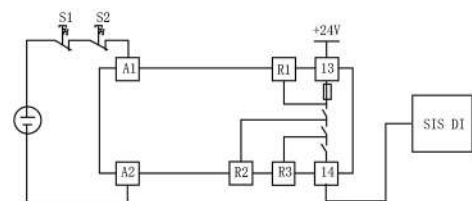

SIS系统DI信号配套 SIS controller DI signals

## 外形尺寸 Outline and dimensions

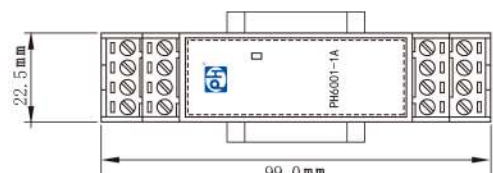

Thickness 114.5mm × width 22.5mm × height 99mm

# PH6002-2A

适用于SIS系统中DI/DO信号

Applied in SIS controller DI/DO signals input



### 电源特性 Power data

供电电压 Supply voltage	17V~35V DC
电流损耗 Current consumption	≤60mA (24V DC, for each channel)

### 输入特性 Input data

通道数 Number of channels	2
输入电流 Input current	≤60mA (24V DC)
导线电阻 Cable resistance	≤15Ω
输入设备 Input devices	SIS系统DI/DO信号配套 SIS controller DI/DO signals

### 输出特性 Output data

触点数量 Number of contacts	2NO (1NO for each channel)
触点材料 Contact material	AgSnO <sub>2</sub>
触点熔丝保护 Excontact fuse protection	5A (Internal)
切换容量 Utilisation category	5A/230V AC; 5A/24V DC

### 时间特性 Time data

吸合缓冲时间 Switch-on delay	≤30ms
释放缓冲时间 Delay-on de-energisation	≤30ms
恢复时间 Recovery time	≤30ms
电源短时中断 Supply short interruption	20ms

### 环境特性 Environmental data

电磁兼容 EMC	EN60947, EN61000-6-2, EN61000-6-4
振动频率 Vibration frequency	10Hz~55Hz
振动幅度 Vibration amplitude	0.35mm
使用温度 Ambient temperature	-20℃~+60℃
储存温度 Storage temperature	-40℃~+80℃
相对湿度 Relative humidity	10%~90%

### 绝缘特性 Insulation data

过压等级 Overvoltage category	III
污染等级 Pollution degree	2
额定绝缘电压 Rated insulation voltage	250V AC
额定冲击电压 Rated impulse voltage	6000V (1.2/50us)
绝缘强度 Dielectric strength	1500V AC, 1min
电气间隙和爬电距离 Clearance and creepage distance	EN 60947-1

### 功能安全参数 Functional safety parameters

安全完整性等级 SIL	SIL3
硬件故障裕度 HFT	0
危险失效概率 PFH	<1.00E <sup>-09</sup>
平均危险失效时间 MTTFD	-
安全失效分数	>99%

### 产品特征 Features

- 独立双通道 Separate two channels
- 三重冗余 Triple redundancy
- 内部触点熔丝保护 Internal Excontact fuse protection
- 带Proof Test测试端 With proof test terminal

### 功能框图 Block diagram

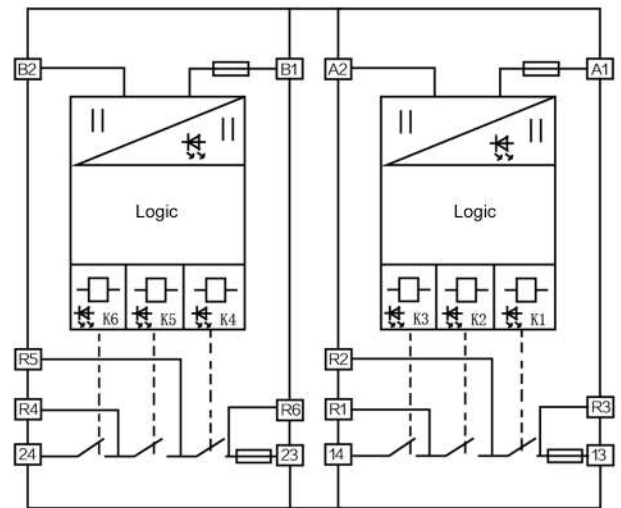

### 接线示意图 Wiring diagram

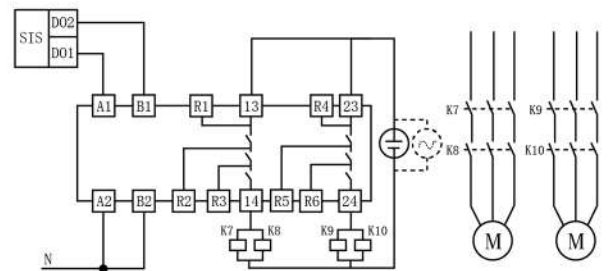

SIS系统DI/DO信号配套 SIS controller DI/DO signals

### 外形尺寸 Outline and dimensions

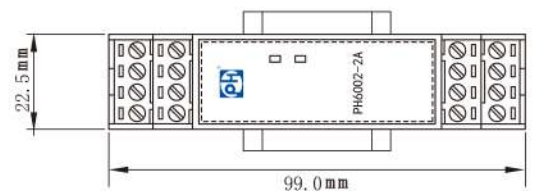

Thickness 114.5mm × width 22.5mm × height 99mm

## PH6003-1A

适用于SIS系统中DI/DO信号输入  
Applied in SIS controller DI/DO signals input

SIL3  
IEC 61508

PLe  
Cat. 4  
EN/ISO13849



## 电源特性 Power data

供电电压 Supply voltage	17V~35V DC
电流损耗 Current consumption	≤60mA (24V DC)

## 输入特性 Input data

通道数 Number of channels	1
输入电流 Input current	≤60mA (24V DC)
导线电阻 Cable resistance	≤15Ω
输入设备 Input devices	SIS系统DI/DO信号配套 SIS controller DI/DO signals

## 输出特性 Output data

触点数量 Number of contacts	1NO
触点材料 Contact material	AgSnO <sub>2</sub>
触点熔丝保护 Excontact fuse protection	5A (Internal)
切换容量 Utilisation category	5A/230V AC; 5A/24V DC

## 时间特性 Time data

吸合缓冲时间 Switch-on delay	≤30ms
释放缓冲时间 Delay-on de-energisation	≤30ms
恢复时间 Recovery time	≤30ms
电源短时中断 Supply short interruption	20ms

## 环境特性 Environmental data

电磁兼容 EMC	EN60947, EN61000-6-2, EN61000-6-4
振动频率 Vibration frequency	10Hz~55Hz
振动幅度 Vibration amplitude	0.35mm
使用温度 Ambient temperature	-20℃~+60℃
储存温度 Storage temperature	-40℃~+80℃
相对湿度 Relative humidity	10%~90%

## 绝缘特性 Insulation data

过压等级 Overvoltage category	III
污染等级 Pollution degree	2
额定绝缘电压 Rated insulation voltage	250V AC
额定冲击电压 Rated impulse voltage	6000V (1.2/50us)
绝缘强度 Dielectric strength	1500V AC, 1min
电气间隙和爬电距离 Clearance and creepage distance	EN 60947-1

## 功能安全参数 Functional safety parameters

安全完整性等级 SIL	SIL3
硬件故障裕度 HFT	0
危险失效概率 PFH	<1.00E <sup>-09</sup>
平均危险失效时间 MTTFD	-
安全失效分数	>99%

## 产品特征 Features

- 独立双通道 Separate one channels
- 三重冗余 Triple redundancy
- 内部触点熔丝保护 Internal Excontact fuse protection
- 带Proof Test测试端 With proof test terminal

## 功能框图 Block diagram

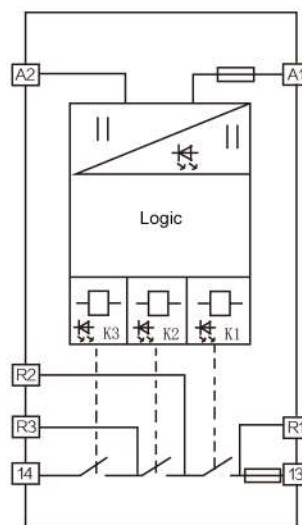

## 接线示意图 Wiring diagram

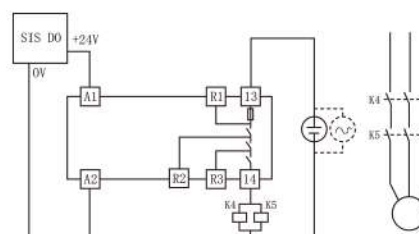

SIS系统DO信号配套 SIS controller DO signals

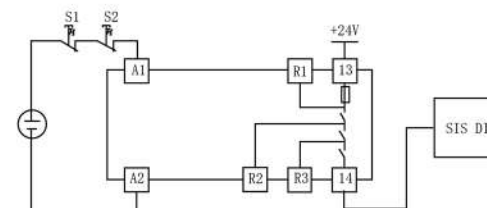

SIS系统DI信号配套 SIS controller DI signals

## 外形尺寸 Outline and dimensions

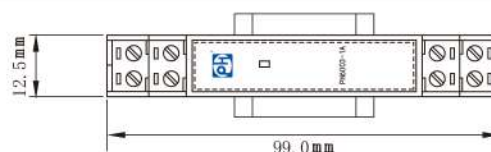

Thickness 114.5mm × width 12.5mm × height 99mm

## PH6003-1B

适用于SIS系统中DI/DO信号

Applied in SIS controller DI/DO signals input

SIL3  
IEC 61508PLe  
Cat. 4  
EN/ISO13849

## 电源特性 Power data

供电电压 Supply voltage	17V~35V DC
电流损耗 Current consumption	≤60mA (24V DC)

## 输入特性 Input data

通道数 Number of channels	1
输入电流 Input current	≤60mA (24V DC)
导线电阻 Cable resistance	≤15Ω
输入设备 Input devices	SIS系统DI/DO信号配套 SIS controller DI/DO signals

## 输出特性 Output data

触点数量 Number of contacts	1NC
触点材料 Contact material	AgSnO <sub>2</sub>
触点熔丝保护 Excontact fuse protection	5A (Internal)
切换容量 Utilisation category	5A/230V AC; 5A/24V DC

## 时间特性 Time data

吸合缓冲时间 Switch-on delay	≤30ms
释放缓冲时间 Delay-on de-energisation	≤30ms
恢复时间 Recovery time	≤30ms
电源短时中断 Supply short interruption	20ms

## 环境特性 Environmental data

电磁兼容 EMC	EN60947, EN61000-6-2, EN61000-6-4
振动频率 Vibration frequency	10Hz~55Hz
振动幅度 Vibration amplitude	0.35mm
使用温度 Ambient temperature	-20℃~+60℃
储存温度 Storage temperature	-40℃~+80℃
相对湿度 Relative humidity	10%~90%

## 绝缘特性 Insulation data

过压等级 Overvoltage category	III
污染等级 Pollution degree	2
额定绝缘电压 Rated insulation voltage	250V AC
额定冲击电压 Rated impulse voltage	6000V (1.2/50us)
绝缘强度 Dielectric strength	1500V AC, 1min
电气间隙和爬电距离 Clearance and creepage distance	EN 60947-1

## 功能安全参数 Functional safety parameters

安全完整性等级 SIL	SIL3
硬件故障裕度 HFT	0
危险失效概率 PFH	<1.00E <sup>-09</sup>
平均危险失效时间 MTTFD	-
安全失效分数	>99%

## 产品特征 Features

- 独立双通道 Separate one channels
- 三重冗余 Triple redundancy
- 内部触点熔丝保护 Internal Excontact fuse protection
- 常闭输出形式 Normally closed output form

## 功能框图 Block diagram

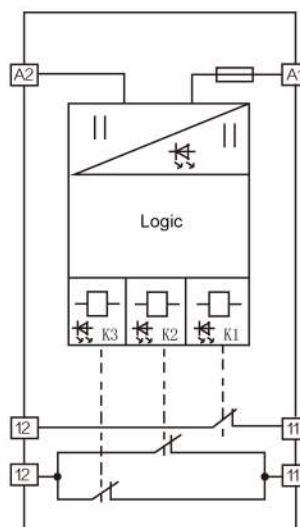

## 接线示意图 Wiring diagram

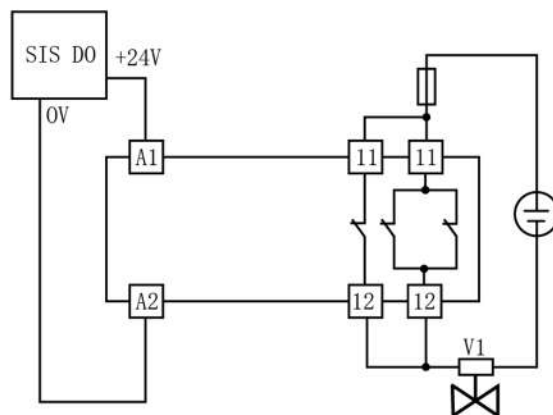

SIS系统DO信号配套 SIS controller DO signals

## 外形尺寸 Outline and dimensions

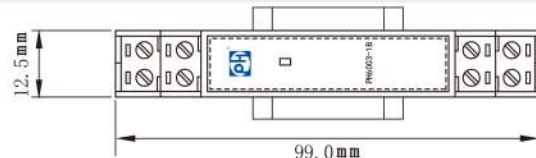

Thickness 114.5mm × width 12.5mm × height 99mm



# PH6004-3A1B

适用于急停按钮、安全门控开关、SIS系统中DO信号  
Applied in E-Stop Buttons, Safety Gates, SIS controller DO signals input



## 电源特性 Power data

供电电压 Supply voltage	24V DC/AC
电压容差 Voltage tolerance	0.85~1.1
电流损耗 Current consumption	≤90mA (24V DC); ≤180mA (24V AC)

## 输入特性 Input data

输入电流 Input current	≤50mA (24V DC)
导线电阻 Cable resistance	≤15Ω
输入设备 Input devices	SIS系统DO信号配套 SIS controller DO signals

## 输出特性 Output data

触点数量 Number of contacts	3NO+1NC
触点材料 Contact material	AgSnO <sub>2</sub> +0.2μm Au
触点熔丝保护 Excontact fuse protection	10A gL/gG NEOZED (NO); 6A gL/gG NEOZED (NC)
切换容量 Utilisation category	EN60947-5-1: AC-15,5A/230V; DC-13,5A/24V

## 时间特性 Time data

吸合缓冲时间 Switch-on delay	≤300ms
释放缓冲时间 Delay-on de-energisation	≤30ms
恢复时间 Recovery time	≤100ms
电源短时中断 Supply short interruption	20ms

## 环境特性 Environmental data

电磁兼容 EMC	EN60947, EN61000-6-2, EN61000-6-4
振动频率 Vibration frequency	10Hz~55Hz
振动幅度 Vibration amplitude	0.35mm
使用温度 Ambient temperature	-20℃~+60℃
储存温度 Storage temperature	-40℃~+80℃
相对湿度 Relative humidity	10%~90%

## 绝缘特性 Insulation data

过压等级 Overvoltage category	III
污染等级 Pollution degree	2
额定绝缘电压 Rated insulation voltage	250V AC
额定冲击电压 Rated impulse voltage	6000V (1.2/50us)
绝缘强度 Dielectric strength	1500V AC, 1min
电气间隙和爬电距离 Clearance and creepage distance	EN 60947-1

## 认证 Certification

安全完整性等级 SIL	SIL3
性能等级 Performance level	PLe
安全类别 Category	Cat.4

## 功能安全参数 Functional safety parameters

硬件故障裕度 HFT	1
危险失效概率 PFH	<3.09E <sup>-10</sup>
平均危险失效时间 MTTFD	188 years
安全失效分数	>99%

## 产品特征 Features

- 多触点输出 Several contacts output
- 低启动冲击电流 Low start-up inrush current

## 功能框图 Block diagram

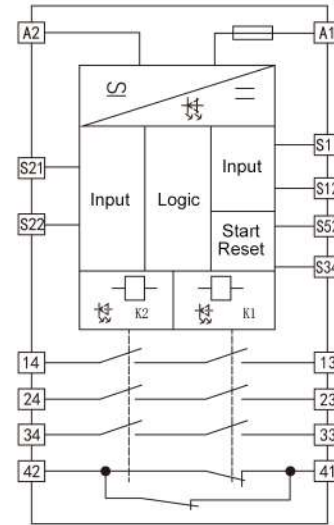

## 接线示意图 Wiring diagram

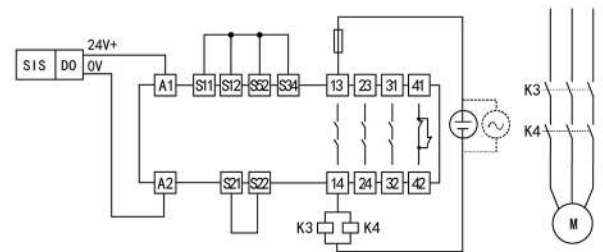

SIS系统DO信号配套 SIS controller DO signals

## 外形尺寸 Outline and dimensions

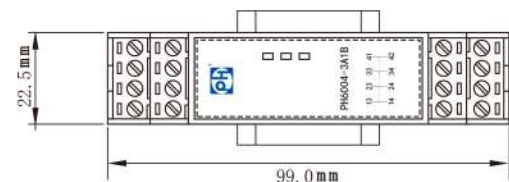

Thickness 114.5mm × width 22.5mm × height 99mm

# PH6005-2A2B

适用于急停按钮、安全门控开关、SIS系统中DO信号输入  
Applied in E-Stop Buttons, Safety Gates, SIS controll DO signals input



## 电源特性 Power data

供电电压 Supply voltage	24V DC/AC
电压容差 Voltage tolerance	0.85~1.1
电流损耗 Current consumption	≤90mA (24V DC); ≤180mA (24V DC)

## 输入特性 Input data

输入电流 Input current	≤50mA (24V DC)
导线电阻 Cable resistance	≤15Ω
输入设备 Input devices	SIS系统DO信号配套 SIS controller DO signals

## 输出特性 Output data

触点数量 Number of contacts	2NO+2NC
触点材料 Contact material	AgSnO <sub>2</sub> +0.2μm Au
触点熔丝保护 Excontact fuse protection	10A gL/gG NEOZED (NO); 6A gL/gG NEOZED (NC)
切换容量 Utilisation category	EN60947-5-1: AC-15,5A/230V; DC-13,5A/24V

## 时间特性 Time data

吸合缓冲时间 Switch-on delay	≤300ms
释放缓冲时间 Delay-on de-energisation	≤30ms
恢复时间 Recovery time	≤100ms
电源短时中断 Supply short interruption	20ms

## 环境特性 Environmental data

电磁兼容 EMC	EN60947, EN61000-6-2, EN61000-6-4
振动频率 Vibration frequency	10Hz~55Hz
振动幅度 Vibration amplitude	0.35mm
使用温度 Ambient temperature	-20℃~+60℃
储存温度 Storage temperature	-40℃~+80℃
相对湿度 Relative humidity	10%~90%

## 绝缘特性 Insulation data

过压等级 Overvoltage category	III
污染等级 Pollution degree	2
额定绝缘电压 Rated insulation voltage	250V AC
额定冲击电压 Rated impulse voltage	6000V (1.2/50us)
绝缘强度 Dielectric strength	1500V AC, 1min
电气间隙和爬电距离 Clearance and creepage distance	EN 60947-1

## 认证 Certification

安全完整性等级 SIL	SIL3
性能等级 Performance level	PLe
安全类别 Category	Cat.4

## 功能安全参数 Functional safety parameters

硬件故障裕度 HFT	1
危险失效概率 PFH	<3.09E <sup>-10</sup>
平均危险失效时间 MTTFD	188 years
安全失效分数	>99%

## 产品特征 Features

- 多触点输出 Several contacts output
- 低启动冲击电流 Low start-up inrush current

## 功能框图 Block diagram

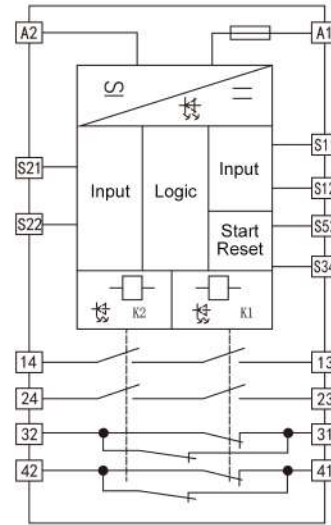

## 接线示意图 Wiring diagram

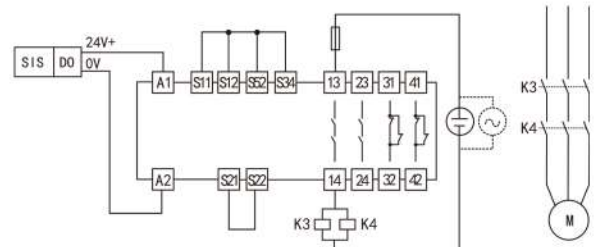

SIS系统DO信号配套 SIS controller DO signals

## 外形尺寸 Outline and dimensions

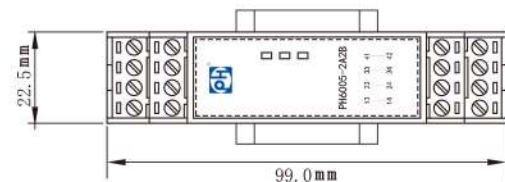

Thickness 114.5mm × width 22.5mm × height 99mm

# 主要应用领域

MAIN APPLICATION AREAS

石油  
Petroleum



化工  
chemical

制药  
pharmacy



机械设备  
mechanization



## 北京平和创业科技发展有限公司

Beijing pinghe Chuangye Technology Development CO., Ltd

办公地址：北京市大兴区天华大街5号13号楼6层

生产基地：北京市中关村科技园区永兴路25号

京津冀中南高科平和智能产业园

电话：010-61252352/61252312/61256219/61259872

传真：010-61259872-8027

技术支持：400-711-6763

网址：[www.bjpinghe.com](http://www.bjpinghe.com)

E-mail：[linsen@bjpinghe.com](mailto:linsen@bjpinghe.com)

